

- 1. Pilotis
- 2. Abrigo para carros
- 3. Área de serv.
- 4. Quarto emp.
- 5. Acesso social
- 6. Sala
- 7. Quarto
- 8. Cozinha
- 9. Escritório
- 10. Acesso serv.

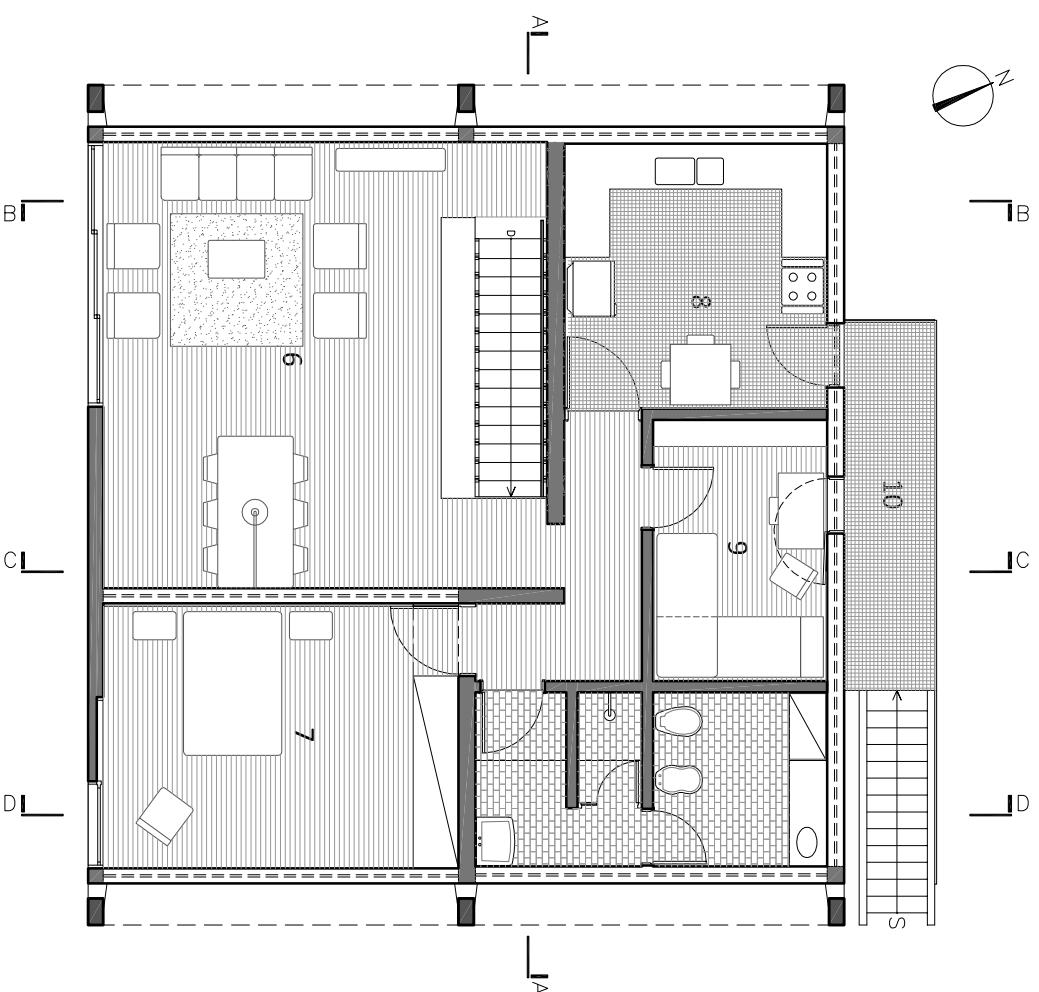

02 PLANTA PAVIMENTO SUPERIOR
ESC 1/100

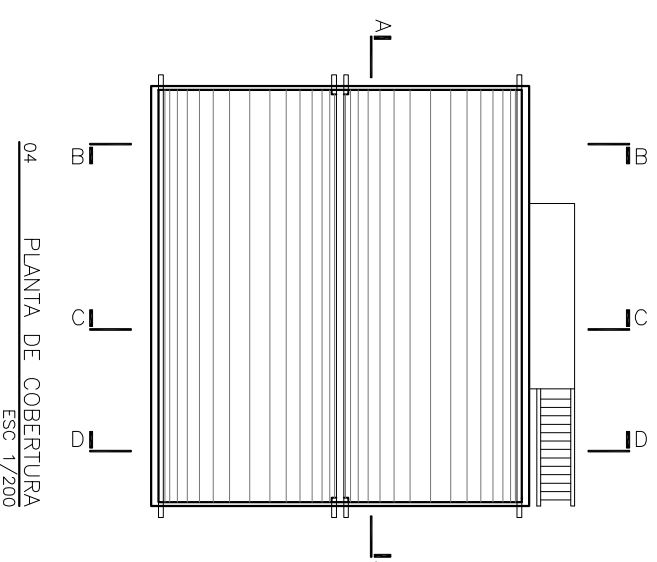

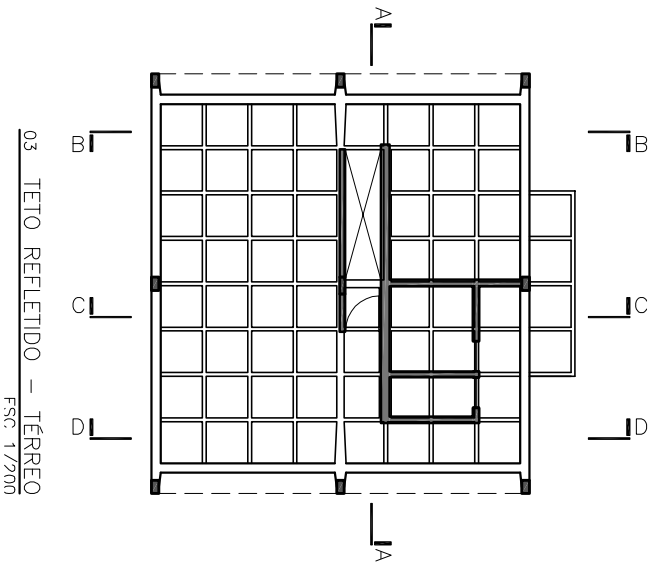
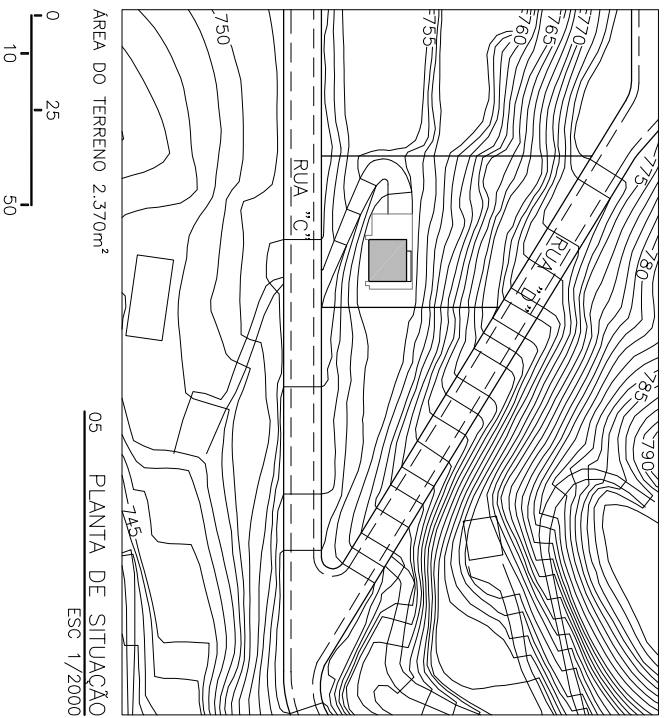
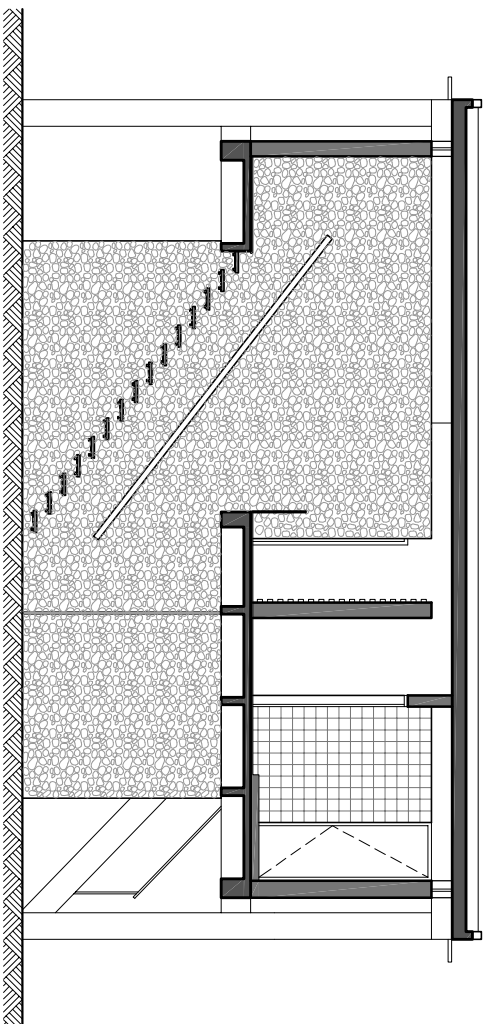

06 CORTE LONGITUDINAL A-A
ESC. 1/100

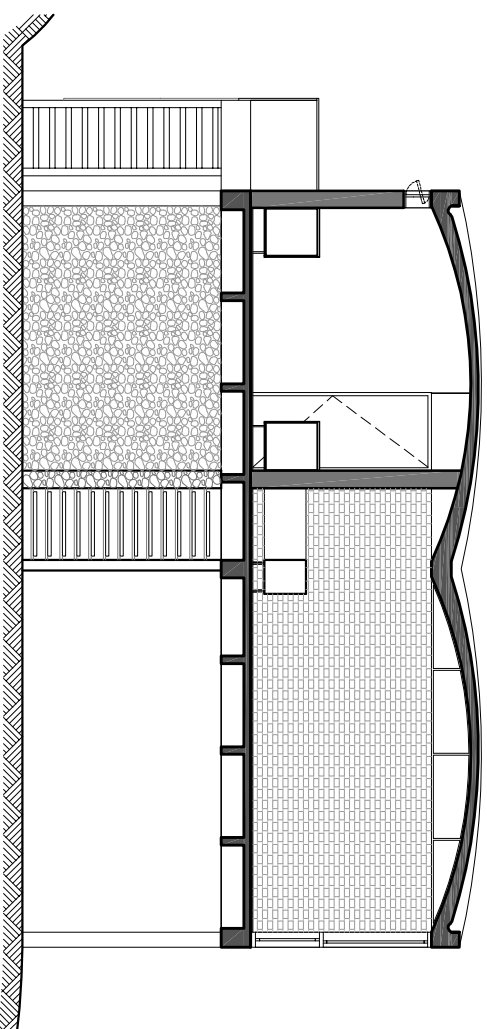

07 CORTE TRANSVERSAL B-B
ESC. 1/100

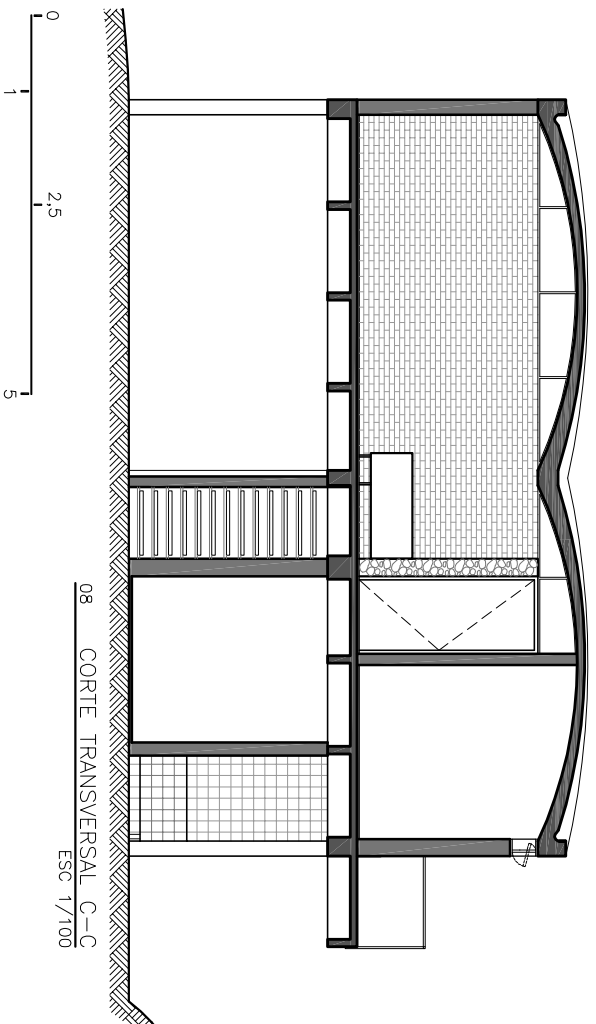

08 CORTE TRANSVERSAL C-C
ESC. 1/100

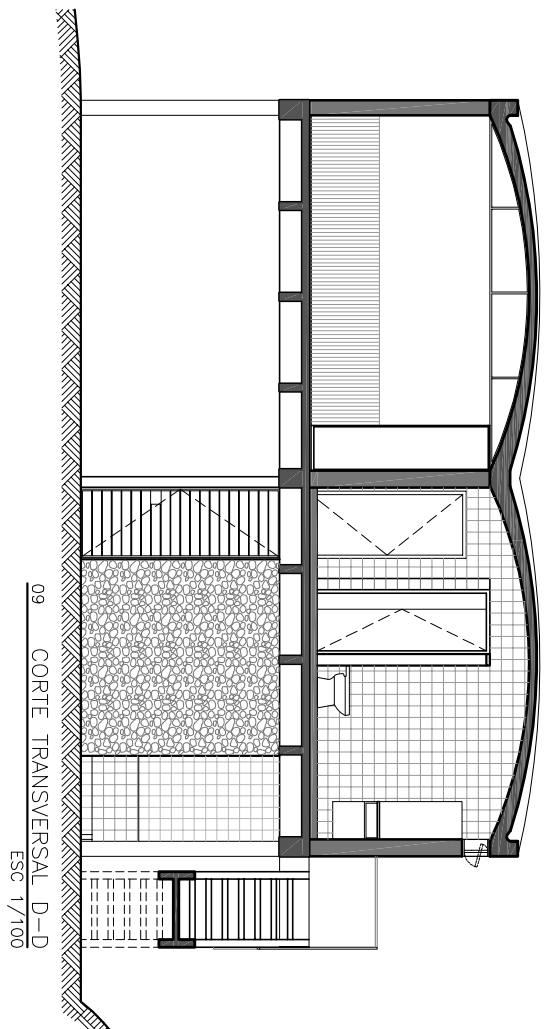

09 CORTE TRANSVERSAL D-D
ESC. 1/100

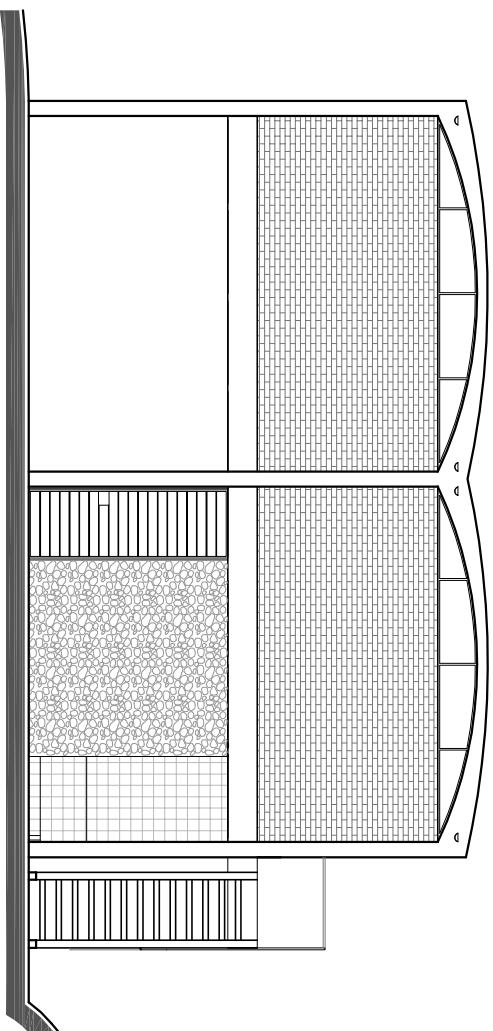

10 FACHADA SUDESTE
ESC. 1/100

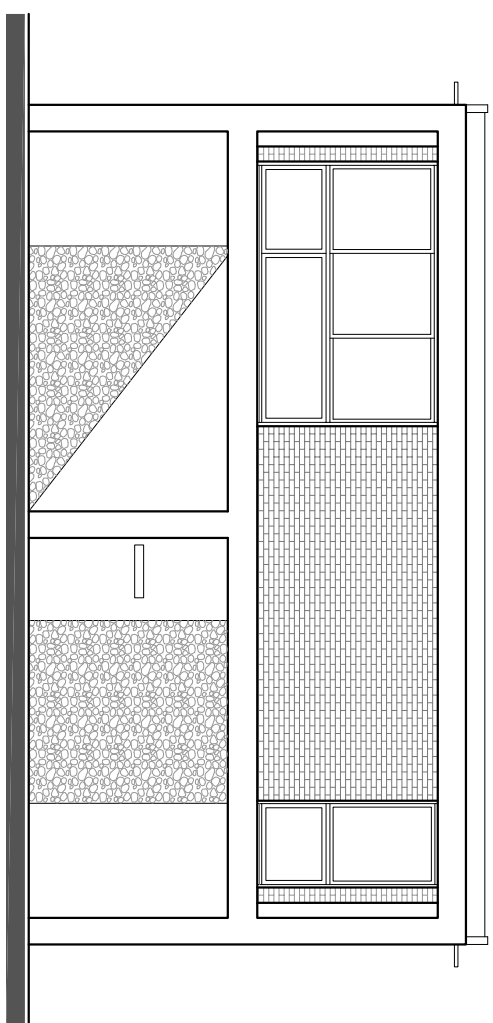

11 FACHADA SUDESTE
ESC. 1/100

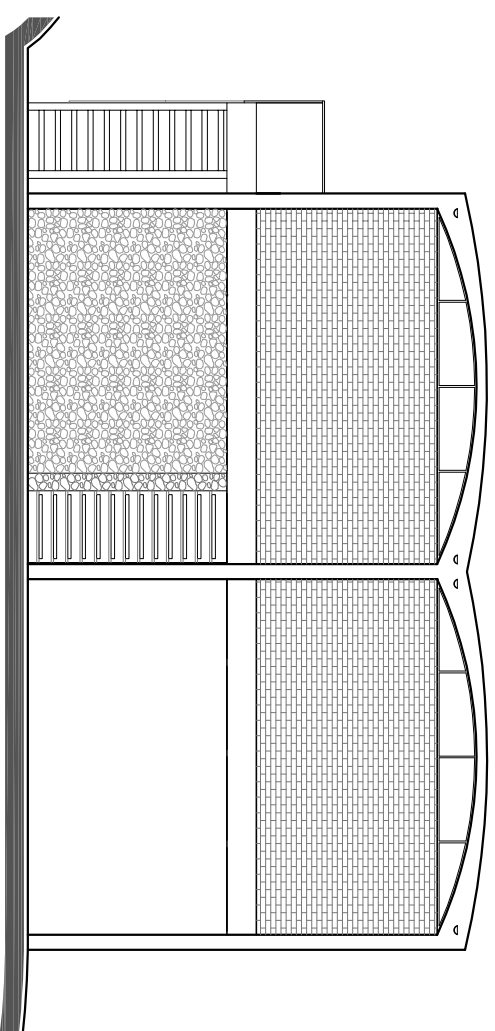

12 FACHADA NOROESTE
ESC. 1/100

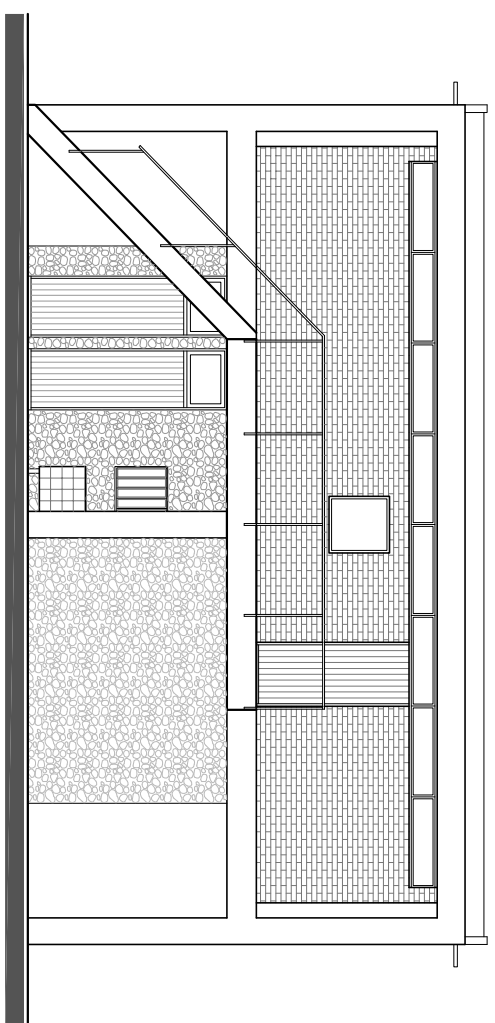

13 FACHADA NOROESTE
ESC. 1/100

